

Building distributor

Introduction

The Budi is a building distributor for a fiber management system that offers the functions of splicing. Provides a mechanical and environmental protection for the fiber optic components.

Kit content

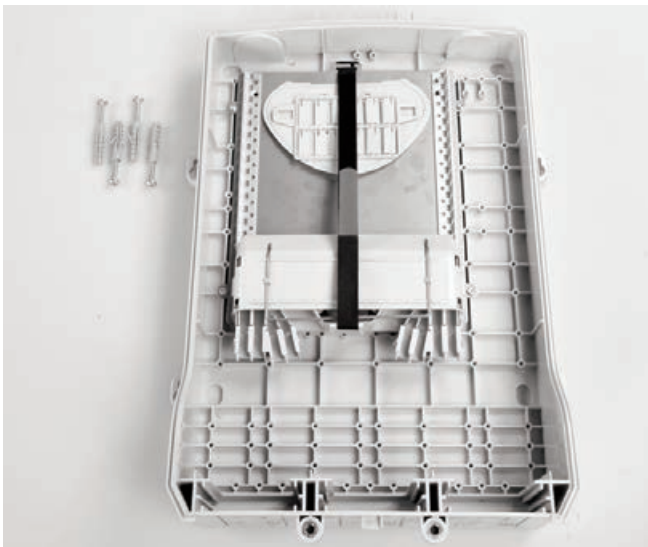

- Box

Accessories

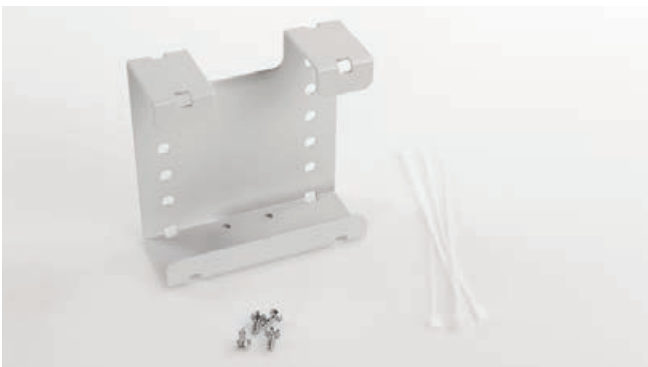

- Loop bracket
Loop of 8 loose tubes (ø 2.4 mm).
Maximum window of 2.6 m.

Seals

Wrap around cable seals

Sealblock 4 x 10 mm

Cable diameter (mm)	Foam (± 5 mm)
3	95
4	90
5	80
6	75
7	70
8	60
9	50
10	40

Sealblock 4 x 15 mm

Cable diameter (mm)	Foam (± 5 mm)
9	125
10	115
11	105
12	95
13	85
14	70
15	60

Sealblock 2 x 20 mm

Cable diameter (mm)	Foam (± 5 mm)
14	155
15	140
16	125
17	110
18	95
19	85
20	75

Sealblock 24 x 7 mm

Cable range 1.8 – 7 mm

Inline seal 1 x 18

To use in ports S4-S5 only
Cable range 3 – 18 mm

Standard seals

PG 16
PG 21
PG 29
PG 29 (PTS 24)

1 Preparation of the box

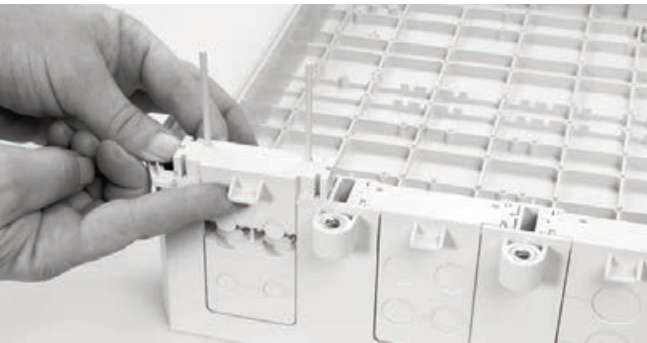
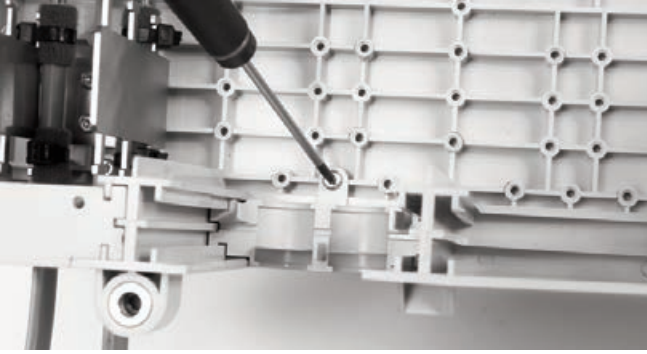

1.1 Different wrap-around ports are available (including brackets). Use two guiding pins to open the ports and to secure the bottom part to the box. Cut out the plastic part if you want to install a cable.

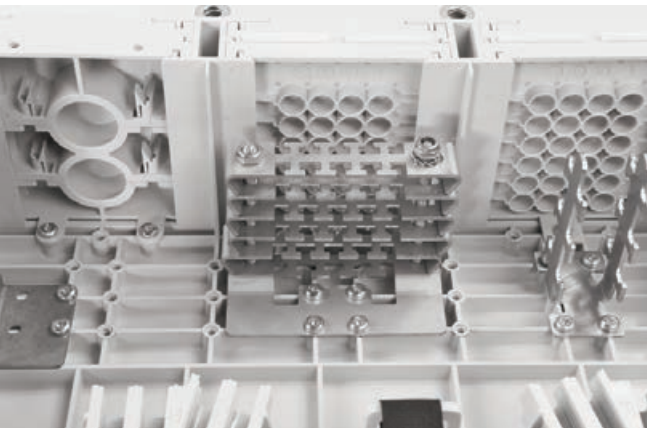

1.2 Install the cable bracket depending the cable seal.

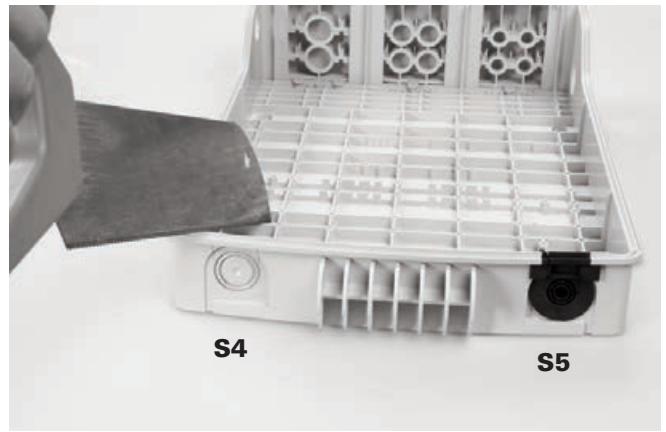

1.3 Use a hacksaw to reach the onion rings, which can be opened with a plier to open the in-line ports (S4/S5).



1.4 Install the wrap-around rubber seal into the port.

2 Looped cable

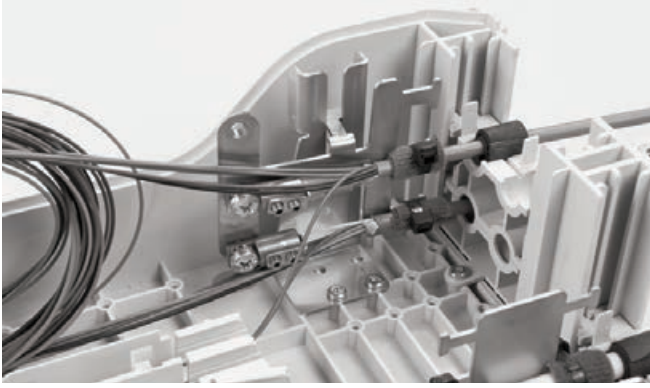

2.1 Install the looped cable into the ports.



2.2 Store the looped tubes into the loop bracket.

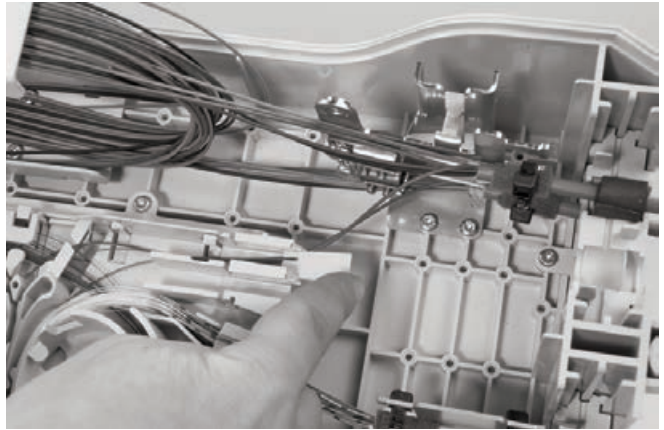
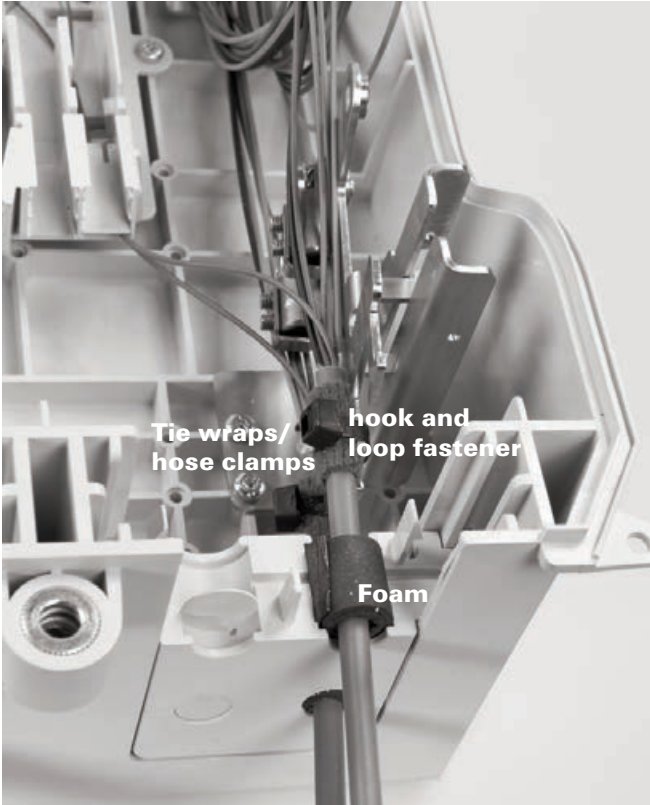

2.3 Route the loose tube towards the FAS block.

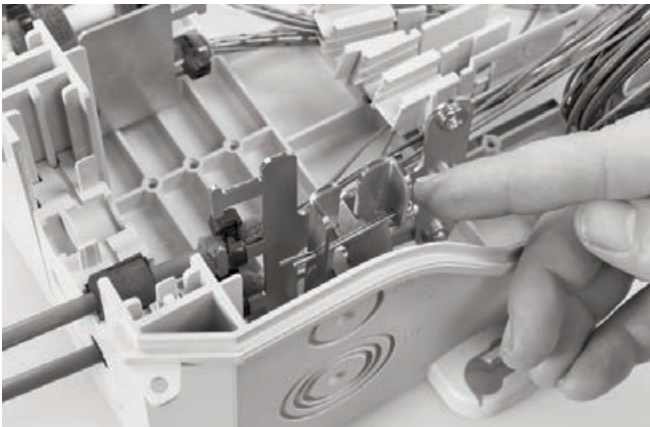

3 Drop cables

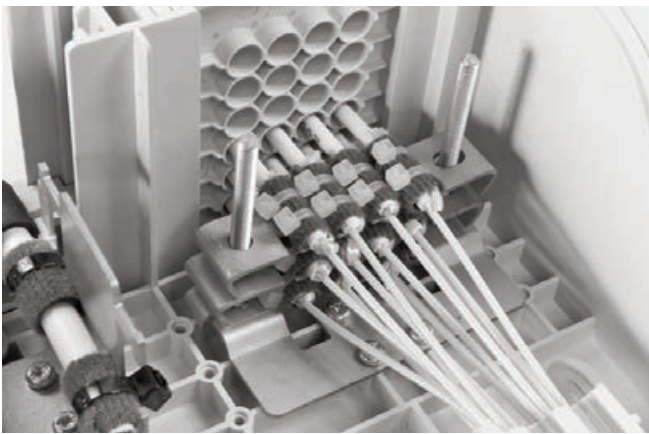
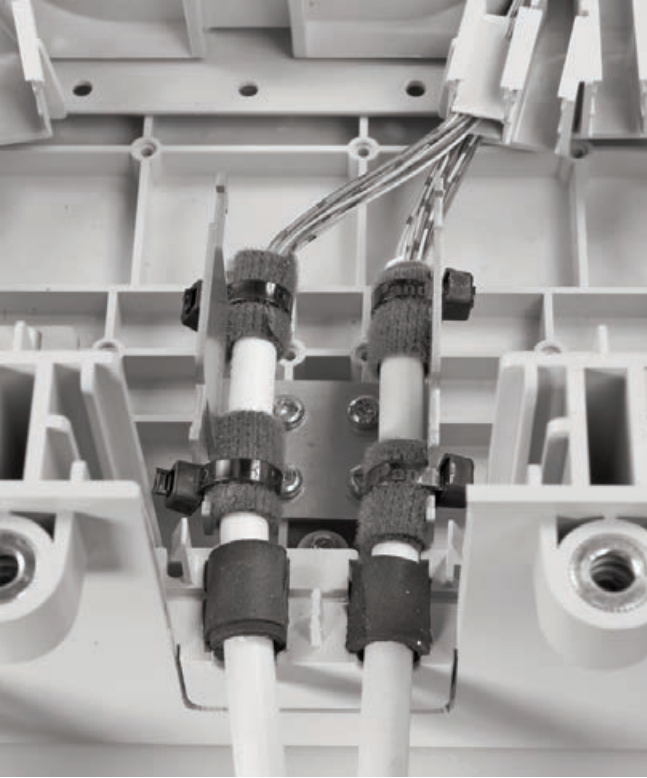

3.1 Install the drop cables into the ports.

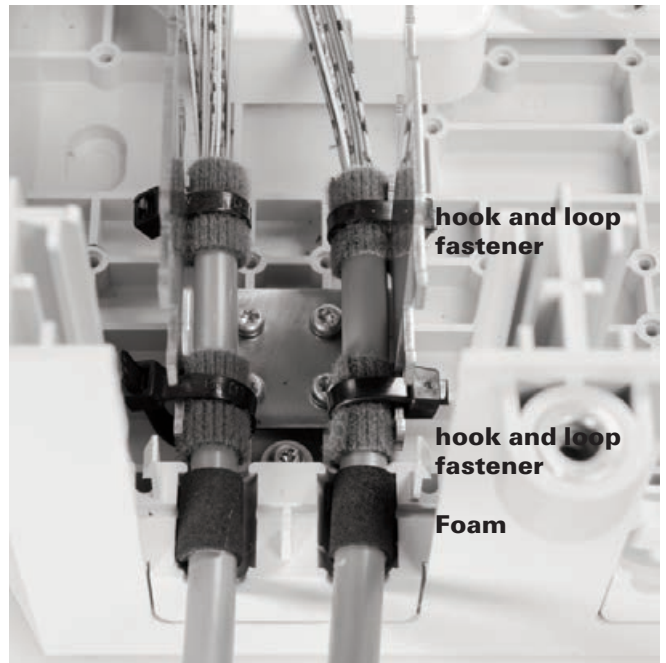

3.2 Install the cable into the port and secure with hook and loop fastener tape onto the bracket and seal with foam (see length page 1).

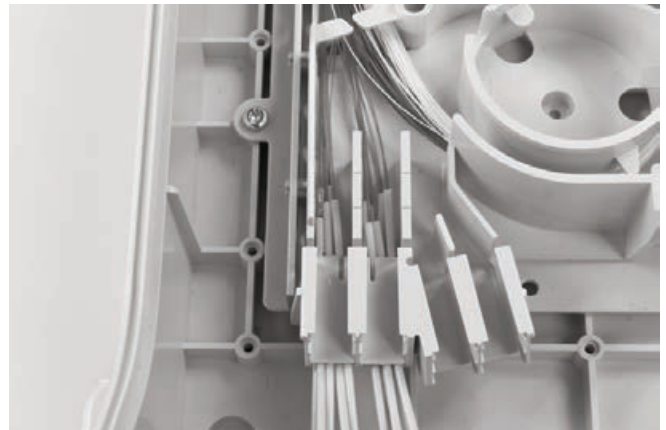

3.3 Route the fibers or tubes towards the FAS block.

4 Fiber routing

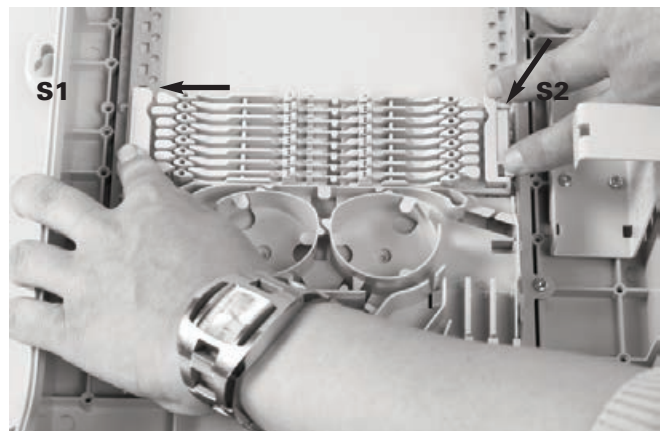

4.1 Secure the wraparound groove plate on the UMS by putting the plate with the long protrusions in the S1 UMS-profile and sliding the plate in the S2 UMS-profile until it snaps. (Do not leave gaps between groove plates).

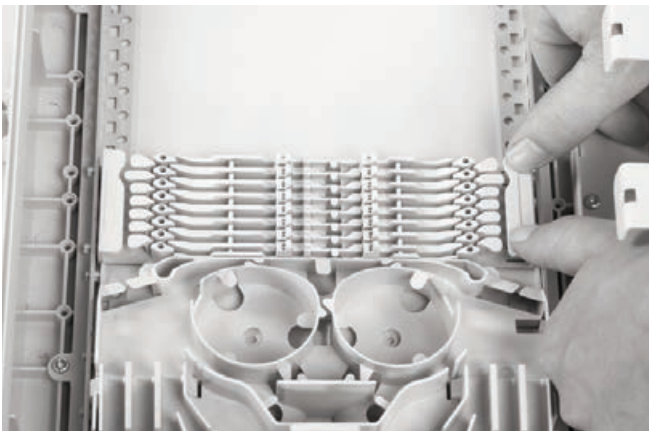

4.2 To remove push the two snapfits at S2 UMS-profile and slide the wraparound plate towards S1 UMS-profile.

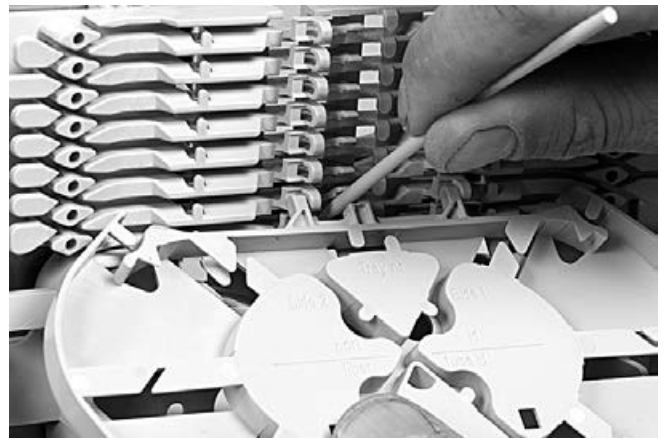

4.4 To remove the tray put the fiber guiding pin between lip on wraparound groove plate and tray and move lateral towards S1.



4.3 Place a tray in the wraparound groove plate; do this by pushing the lip on the groove plate (lowest possible position) slightly down with the tray and move the tray lateral into the hinge-cavities of the groove plate. To snap the High Capacity Single Element tray (HCSE) in the W/a single fiber groove plate **leave always one hinge facility open between Fasblock or previous tray and the HCSE-tray.**

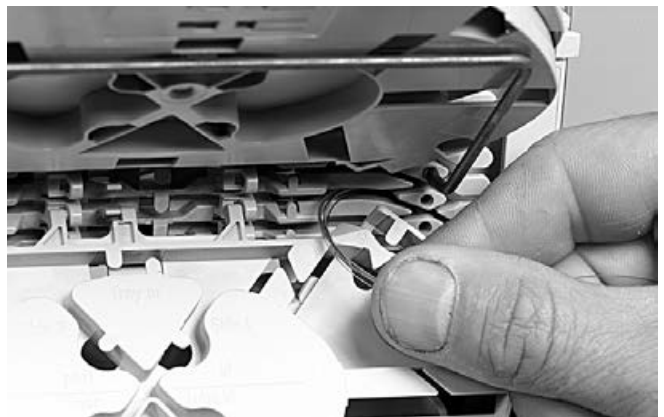

4.5 Position the wedge carefully such that the groove is still accessible for the fibers and be careful not to push the wedge against fibers. To remove the wedge, use two hands to pull on both ends (near the groove plate). Route the fiber in the grooves of the wraparound groove plates to the entrance of the identified tray. Fiber must be routed in the groove below the hinge of the tray!

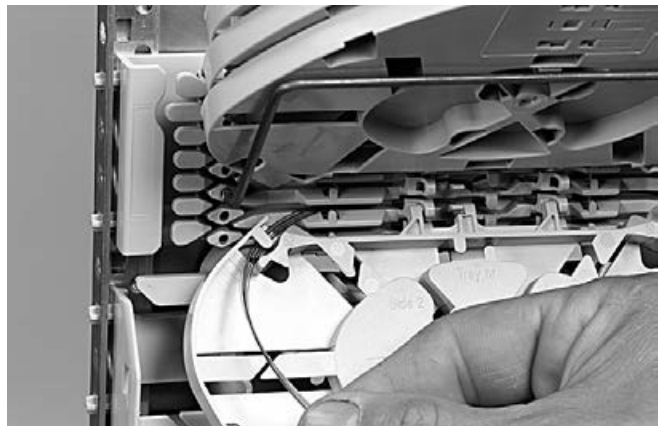

4.6 Pull gently on the fibers in the tray and make sure that the fibers are well contained in the routing block and wraparound groove plate.

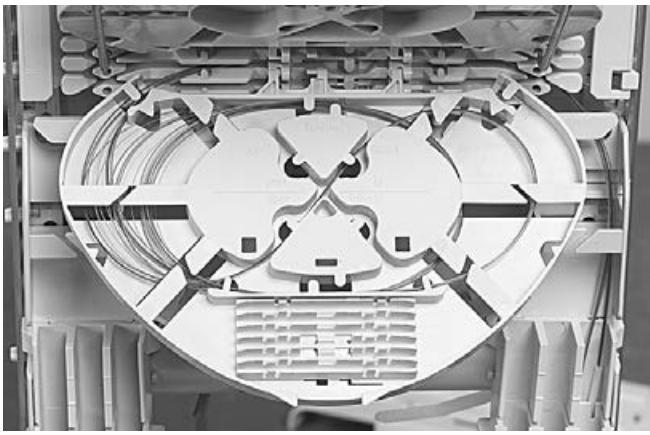

4.7 Store the fibers temporarily on a tray (picture shows the case of a loopback).

4.8 Storing dark fibers can be done in different ways.

- 1) Organise dark fibers into the different trays, following instructions as described.
- 2) Organise dark fibers together into the first available tray (i.e. with a max. of 24cut or 12 loops primary coated fibers in one SE-tray).

5 Trays



5.1 SMOUV in SC tray.



5.2 ANT in SE tray.



5.3 ANT in SC tray.

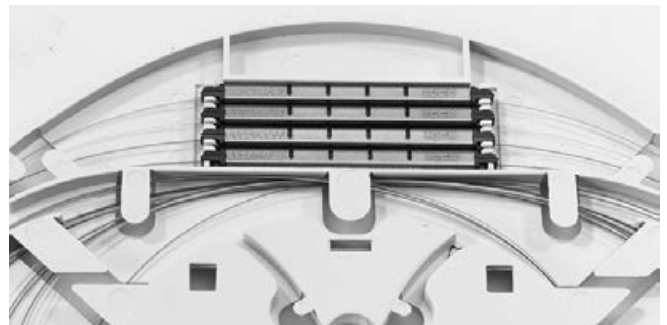

5.4 RECORDsplice in SC tray.

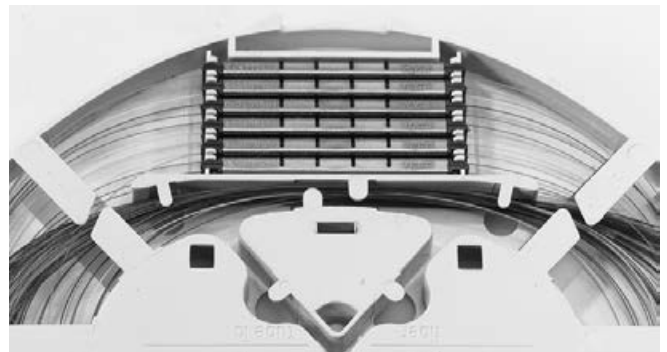

5.5 RECORDsplice in SE tray.



5.6 RECORDsplice/ANT in SC tray.

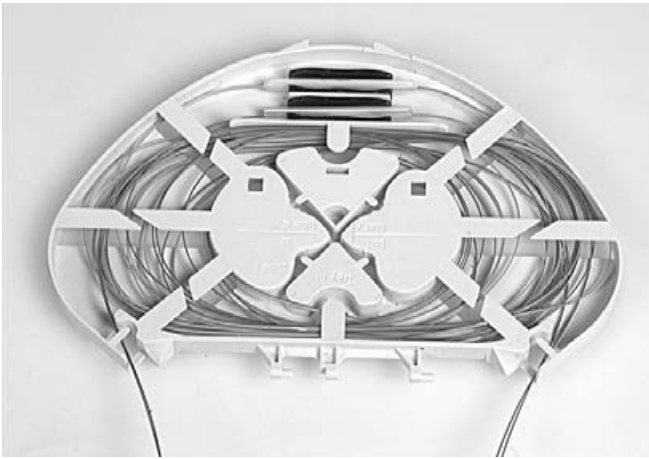

5.7 Ribbon 4/8 tray.

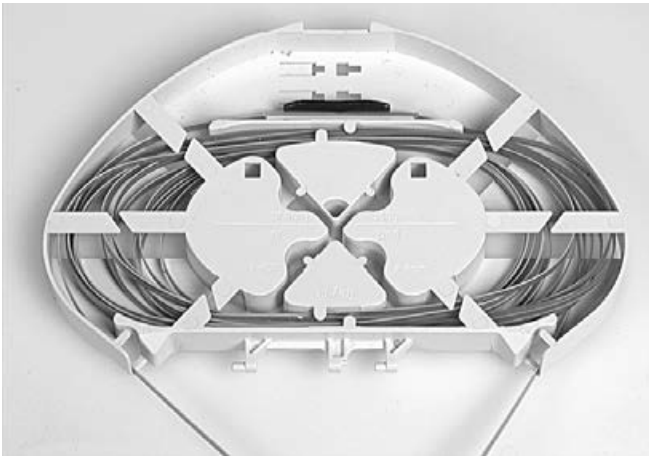

5.8 Ribbon 12 tray.

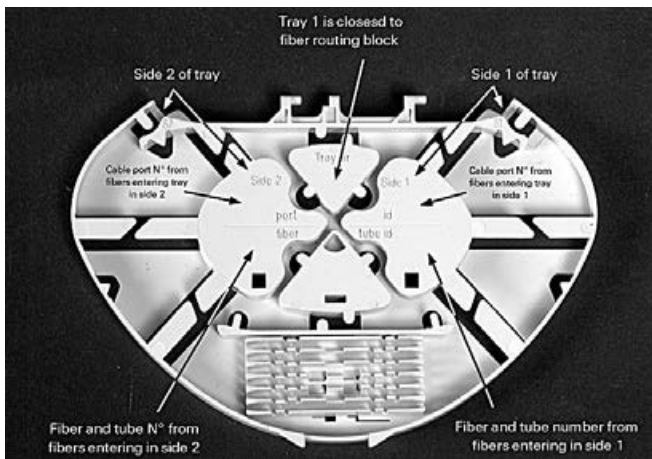

5.9 Use a permanent marker to write on the tray.

6 Closing the box

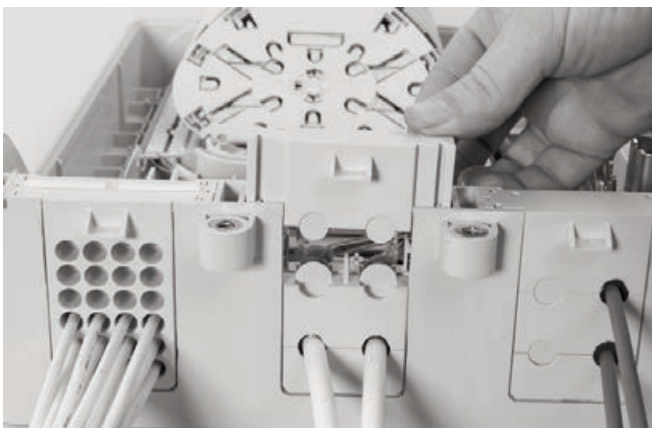
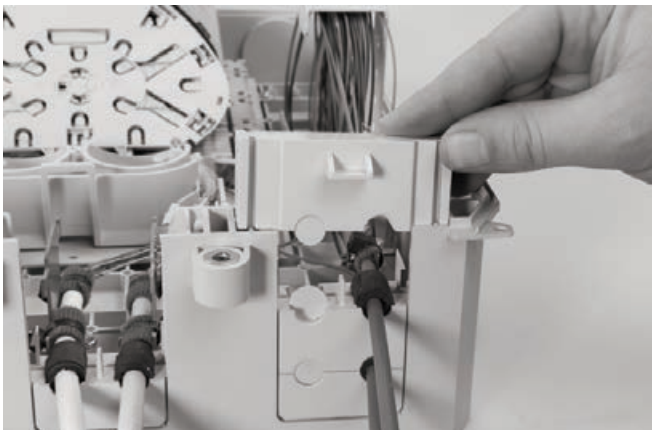

6.1 Close all the ports.



6.2 Close the box.

Tyco Electronics Raychem bvba

Diestsesteenweg 692
B-3010 Kessel-Lo, Belgium
Tel.: 32-16-351 011
Fax: 32-16-351 697
www.telecomnetworks.com
www.te.com

SMOUV, RECORDsplice, TE (logo) and TE Connectivity are trademarks of the TE Connectivity group of companies and its licensors.

While TE Connectivity and its affiliates referenced herein have made every reasonable effort to ensure the accuracy of the information contained in this catalog, TE Connectivity cannot assure that this information is error free. For this reason, TE Connectivity does not make any representation or offer any guarantee that such information is accurate, correct, reliable or current. TE Connectivity reserves the right to make any adjustments to the information at any time. TE Connectivity expressly disclaims any implied warranty regarding the information contained herein, including, but not limited to, the implied warranties of merchantability or fitness for a particular purpose. TE Connectivity' only obligations are those stated in TE Connectivity' Standard Terms and Conditions of Sale. TE Connectivity will in no case be liable for any incidental, indirect or consequential damages arising from or in connection with, including, but not limited to, the sale, resale, use or misuse of its products. Users should rely on their own judgment to evaluate the suitability of a product for a certain purpose and test each product for its intended application.